

# APPROVAL SHEET

To :

Customer P/N :

UDE P/N : L14H001-3

Description : 1000 Base -T

Dual Ports LAN Filter

Meet IEEE802.3 bt type3 standard



**HF**

Halogen  
Free

Spec No.  
LZ0384-00

Update Date  
2019/10/28

Revision  
B

Approved	Checked	Prepared



湧德電子 股份有限公司  
UDE Corp.

桃園市(33852) 蘆竹區內溪路 68 巷13號

No.13, Ln. 68, Neixi Rd., Luzhu Dist., Taoyuan City (33852), Taiwan

TEL: 886-3-3242000 FAX: 886-3-3246611

<http://www.ude-corp.com/>

1. MECHANICAL DIMENSION

1.1 Product Dimension

General Tolerance : X.X : ± 0.25  
 X.XX : ± 0.13

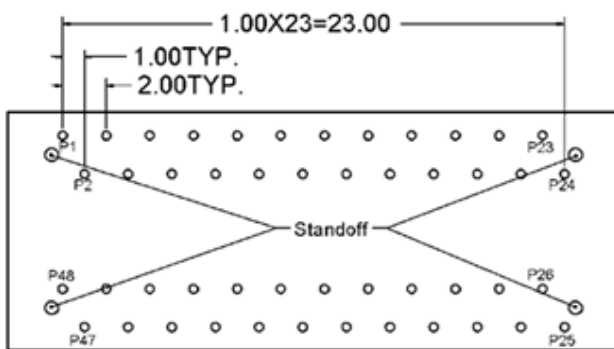
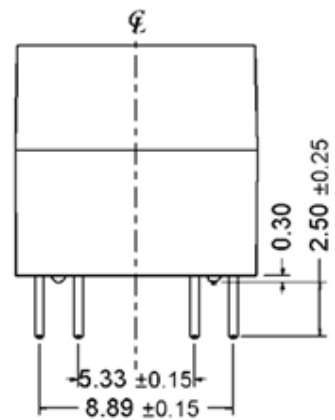
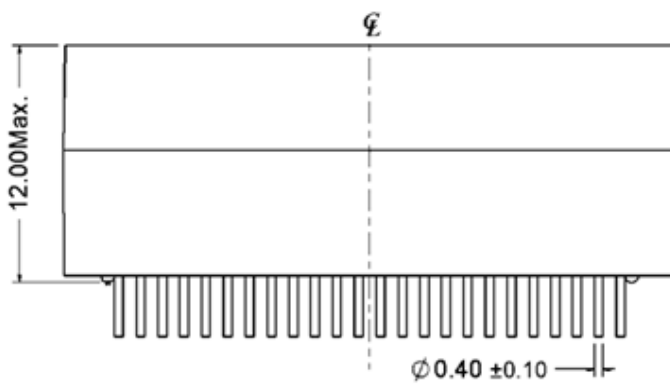
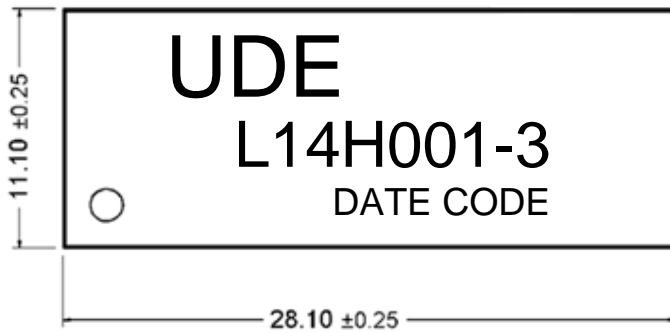

### 1.2 Recommended PCB Layout

#### Component Side of Board

All dimension tolerances are  $\pm 0.08\text{mm}$  unless otherwise specified

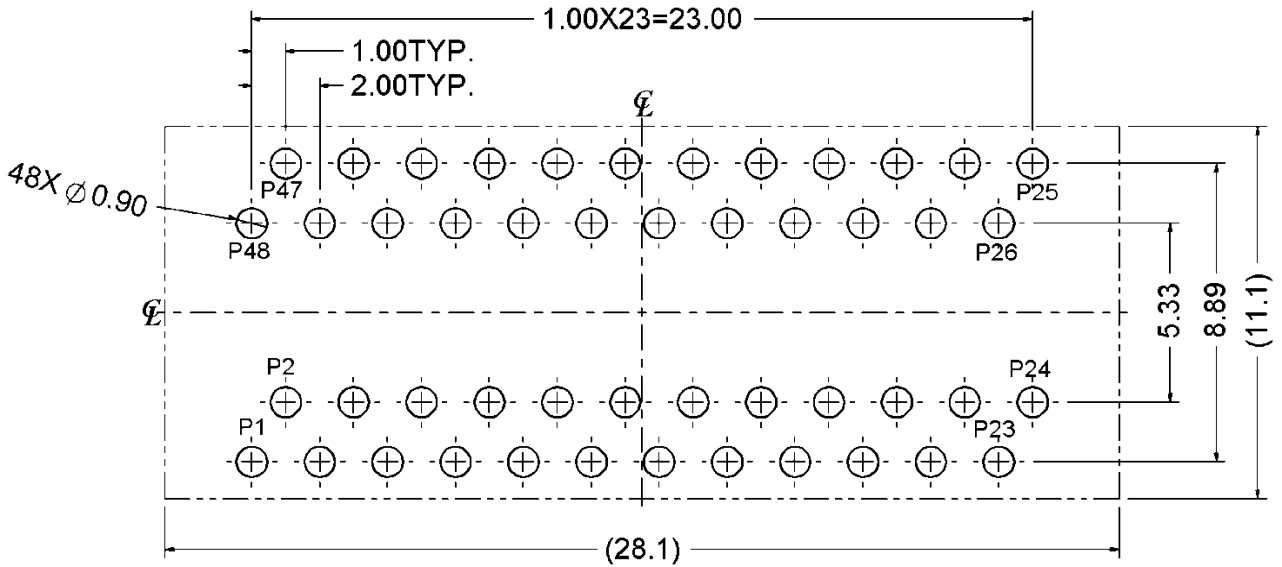

### 1.3 Order Information

L 1 4 H 001 - 3  
 A B C D E F

- A、 Filter
- B、 DIP
- C、 48PIN
- D、 Normal
- E、 Product Numbering
- F、 PoE Plus

## 2. SPECIFICATION

2.1 Designed for Ethernet 1000 Base-T,full Dual ports applications.

2.2 Supports 8 pairs of category 5 UTP cable.

2.3 Cable interface for isolation and low common mode emissions.

2.4 Design to meet IEEE 802.3bt type3 with 720mA balanced current.

2.5 Compliant with RoHS&Halogen Free requirements.

2.6 Operating and Storage Temperature

Operating Temperature : 0°C to +70°C

Storage Temperature : -25°C to +105°C

2.7 Packing Information

18 pcs finished goods per tube.

162 tubes(2916 pcs finished goods) per master carton.

### 3. ELECTRICAL CHARACTERISTICS

#### 3.1 Schematic

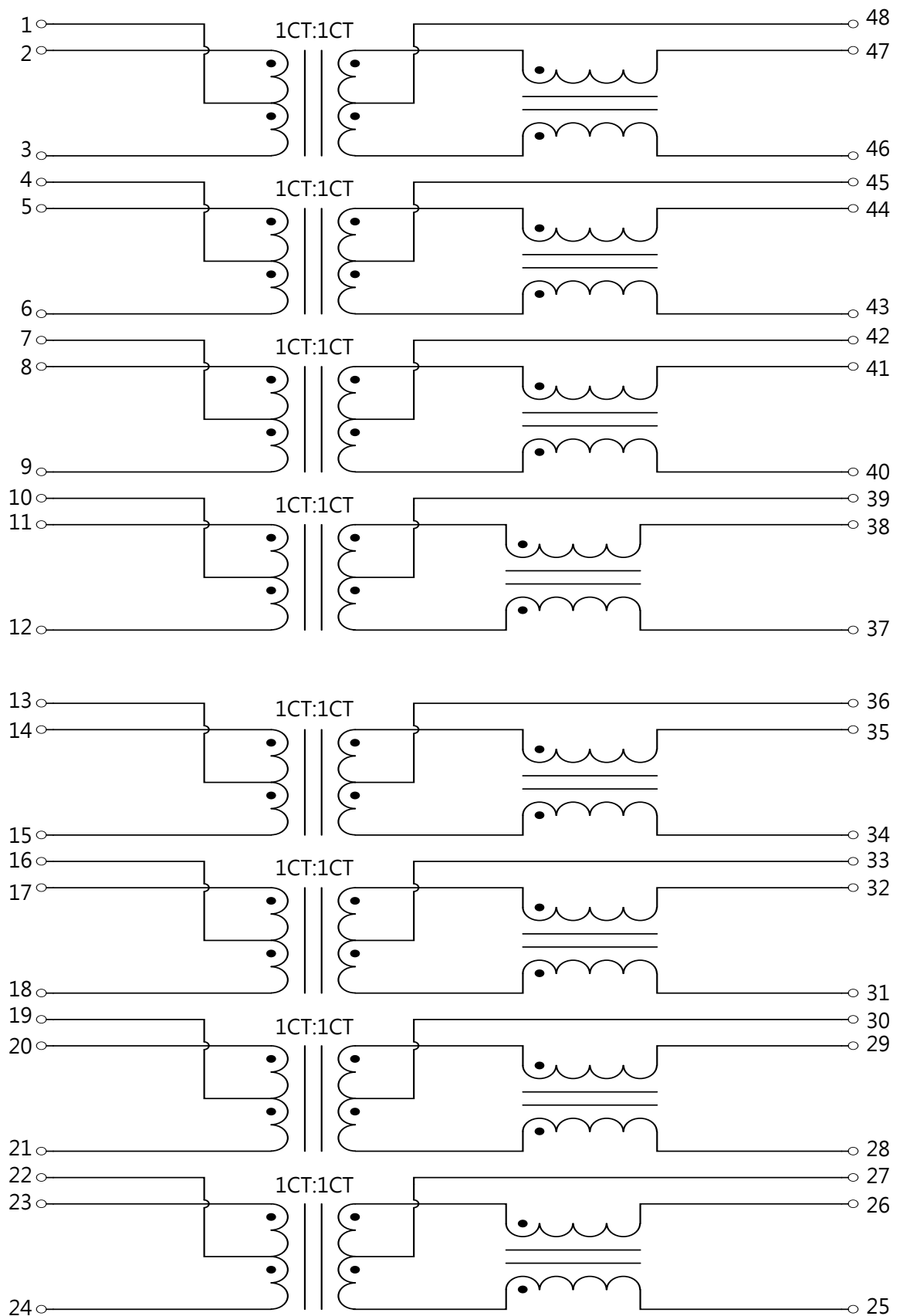

### 3.2 Electrical Specifications @25°C

Type : Balance low pass 100Ω impedance

Insertion loss : 1~100 MHz -1.0dB max.

Return loss : 1~30 MHz -18dB min. load 100Ω

30~60MHz -14dB min. load 100Ω

60~80MHz -12dB min. load 100Ω

80~100MHz -10dB min. load 100Ω

### 3.3 DCMR

@ 30 MHz -40dB min.

@ 60 MHz -35dB min.

@ 100 MHz -30dB min.

### 3.4 Cross Talk

@ 30 MHz -40dB min.

@60 MHz -35dB min.

@ 100 MHz -30dB min.

### 3.5 Inductance

@ 100KHz, 0.1V, 8mA DC BIAS 350uHMin

### 3.6 HiPot Test

@ 1500 Vrms

### 3.7 Turns Ratio

@ 1:1±5%

#### 4. DIPPING TEMPERATURE PROFILE

Recommend Wave Soldering Curve:

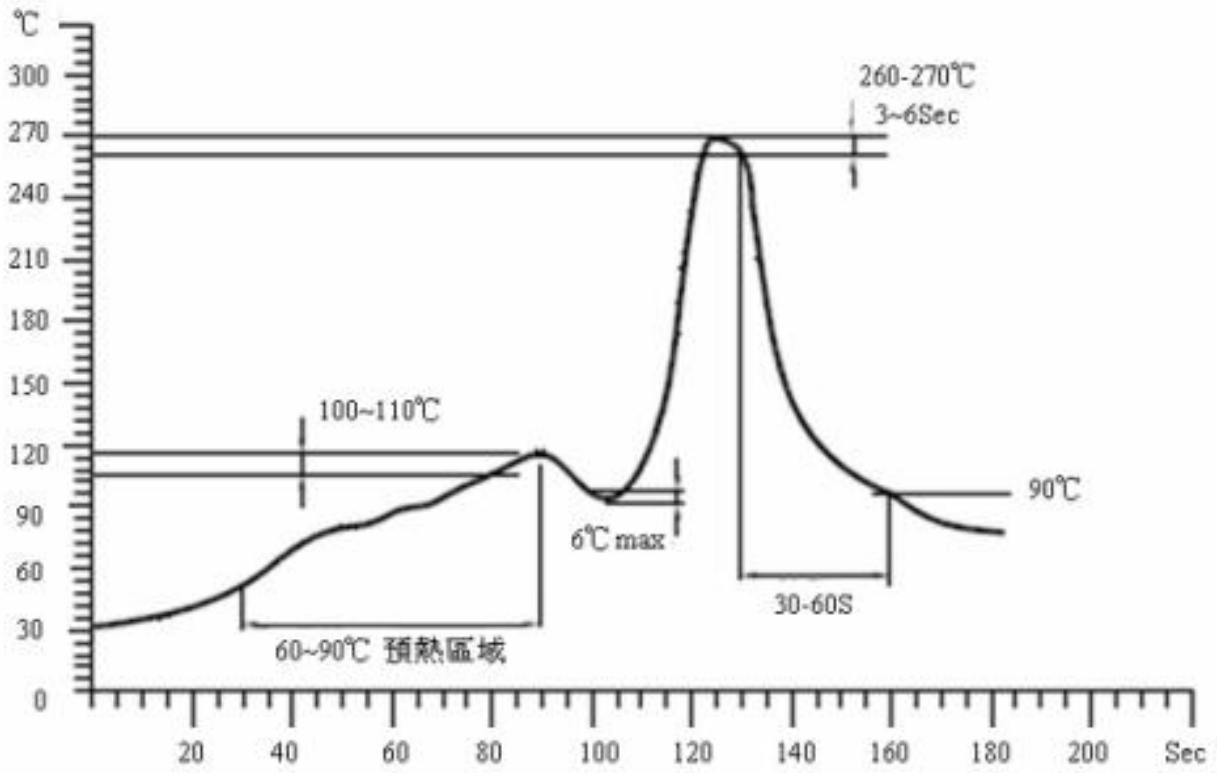

5. Revision History			
Issue Date	Revision	Comments	Operator
2018/8/31	A	Initial Release .	Sandy
2019/10/28	B	Adjusting the Inductance Testing Conditions from 11mA to 8m	Aiai